

PASSI LATERALI

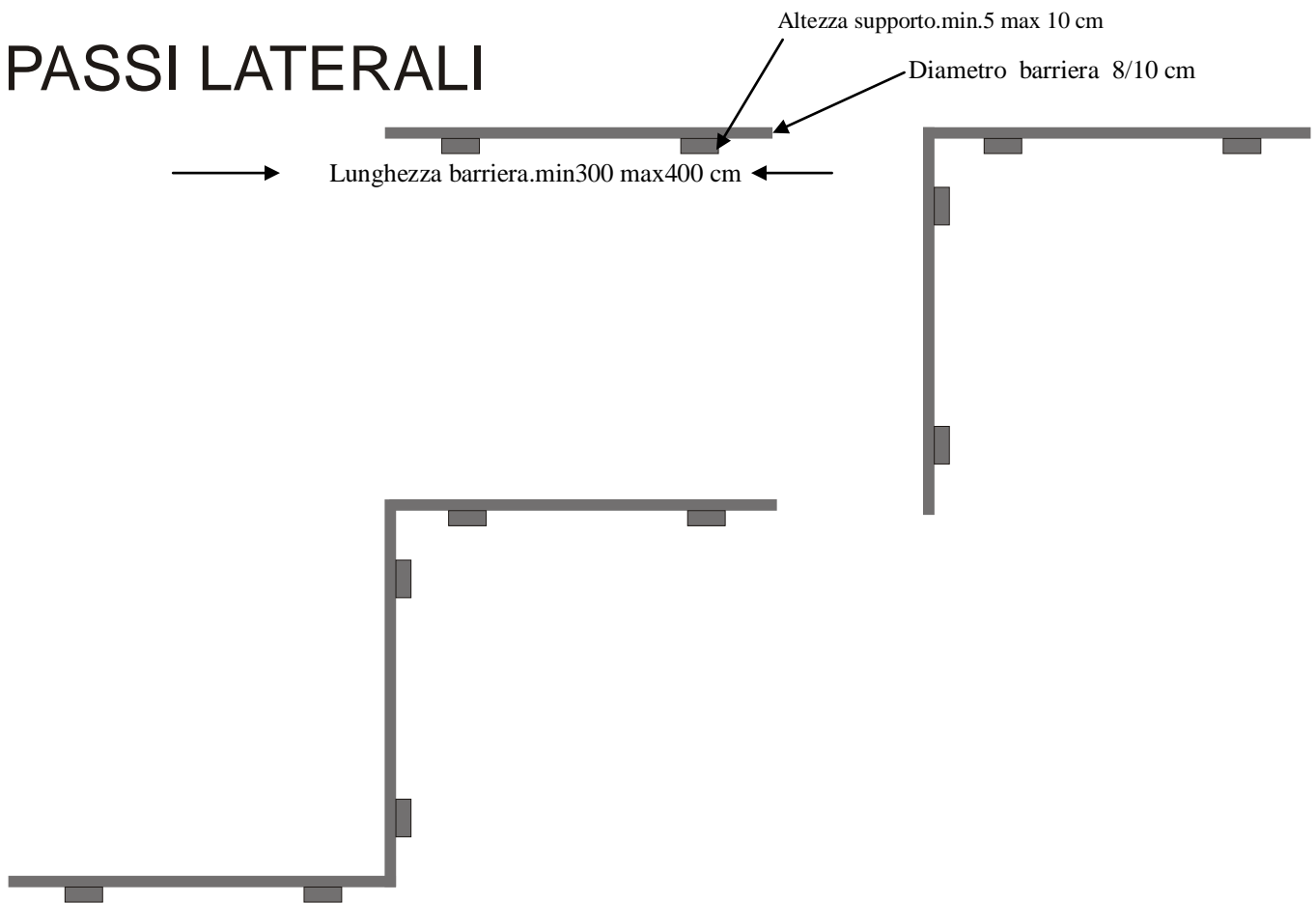

PASSI LATERALI CON SPOSTAMENTO OGGETTO

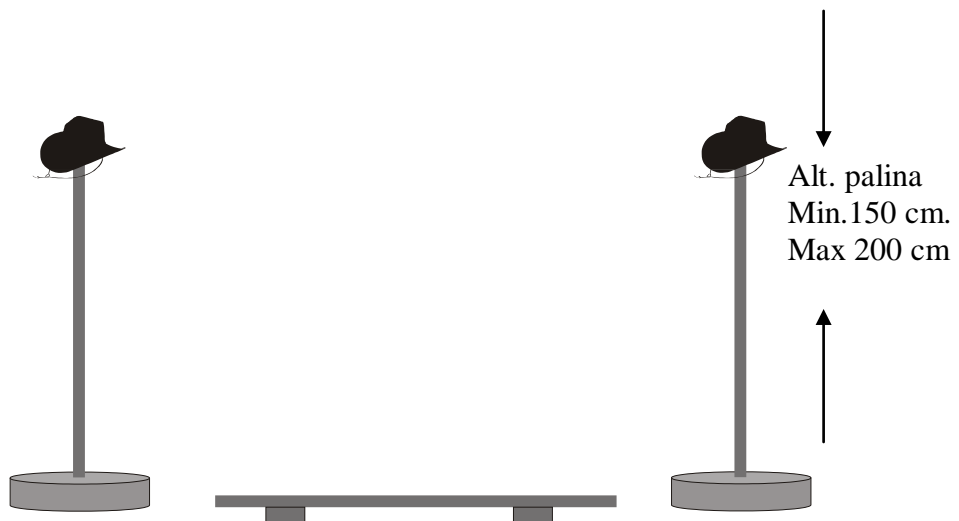

PASSI INDIETRO A SLALOM

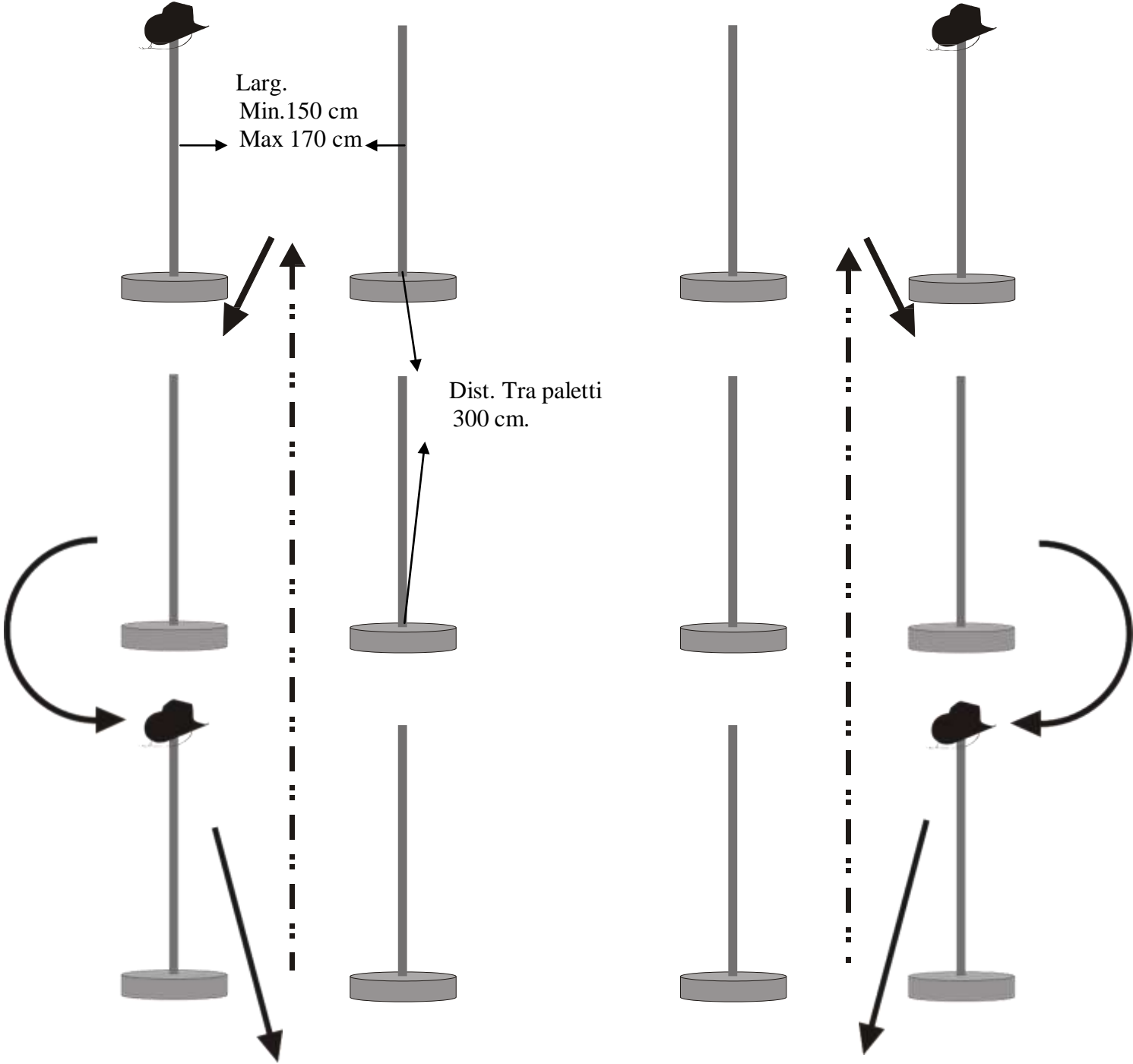

TRASFERIMENTO DI UN OGGETTO

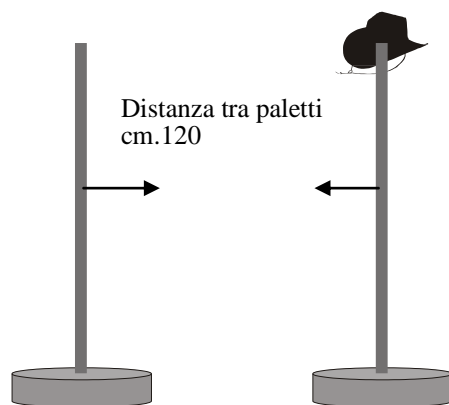

PASSI INDIETRO DIRITTI CON TRASFERIMENTO DI UN OGGETTO

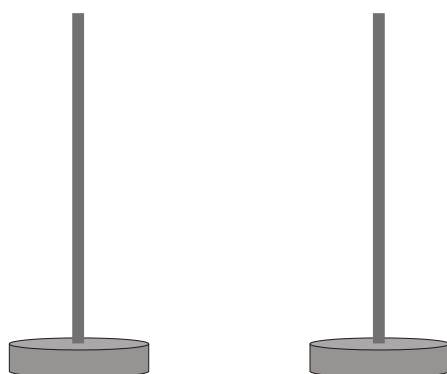
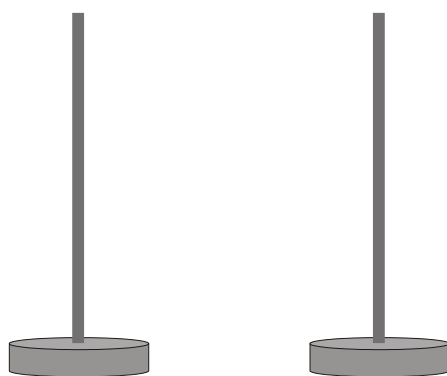
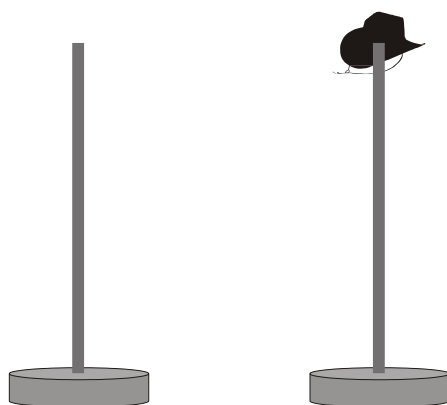

PASSI INDIETRO

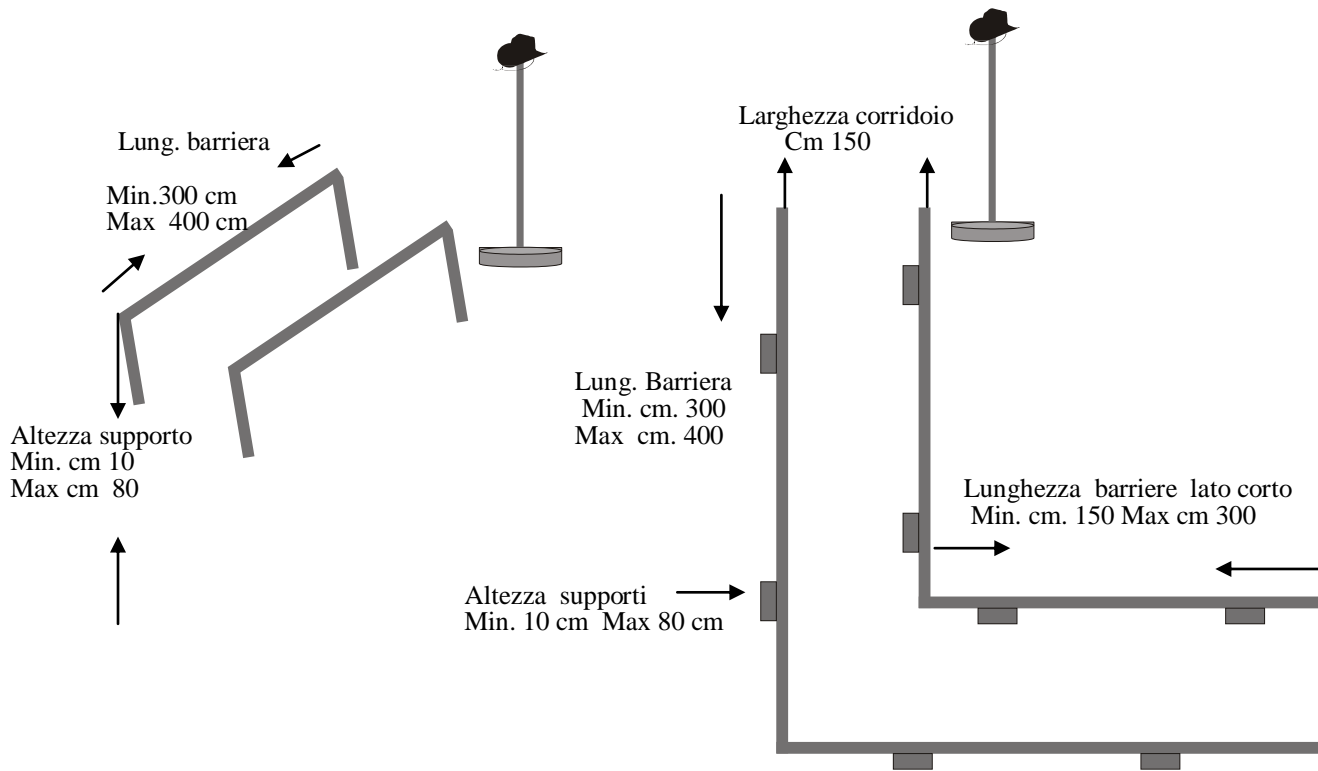

QUADRATO

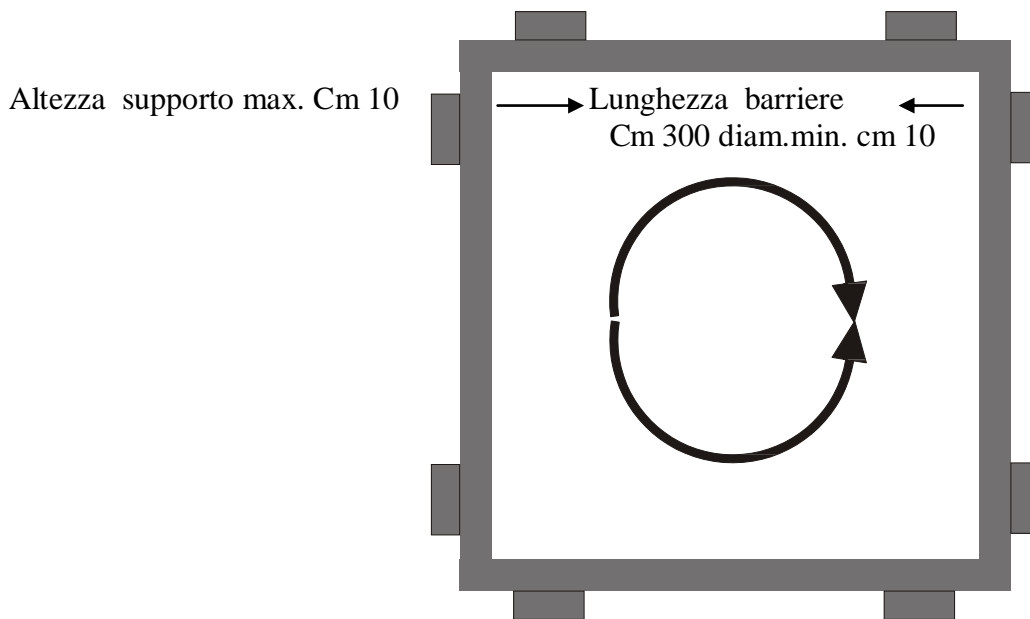

PEDANA

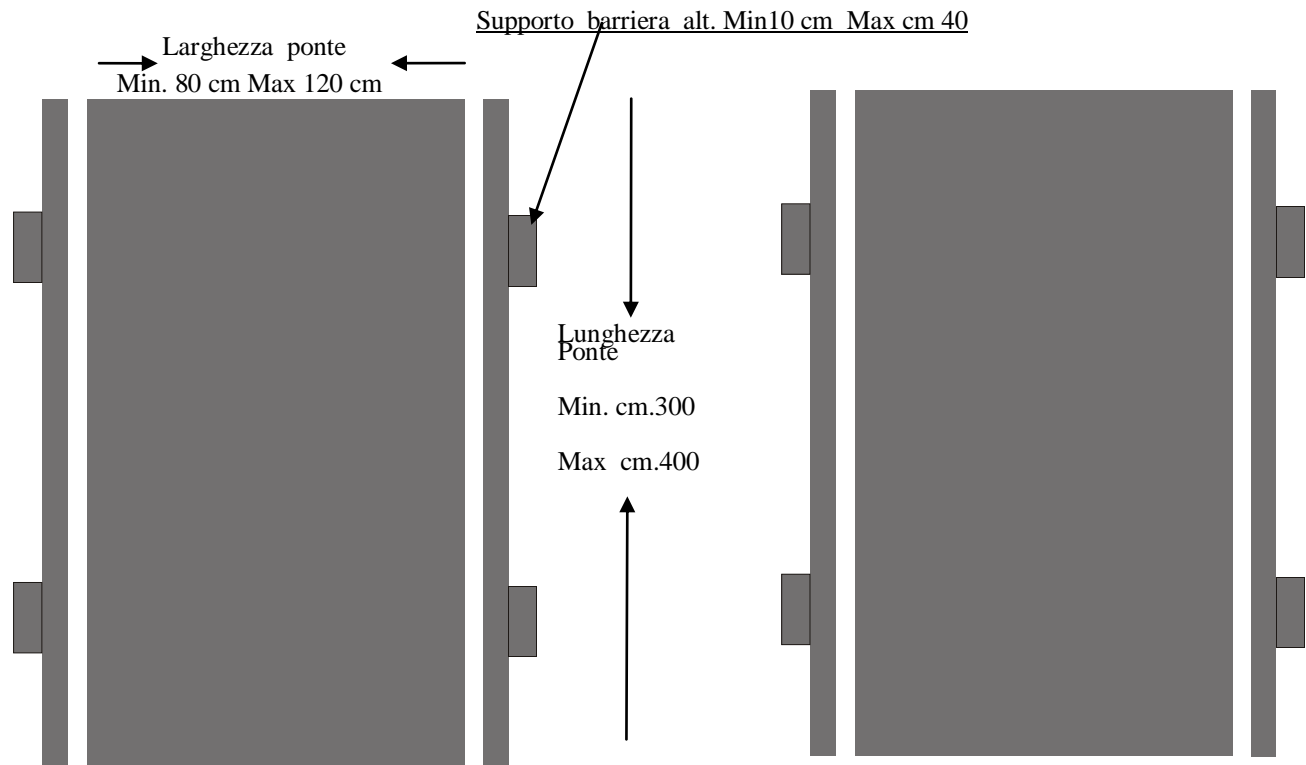

SLALOM IN PARALLELO

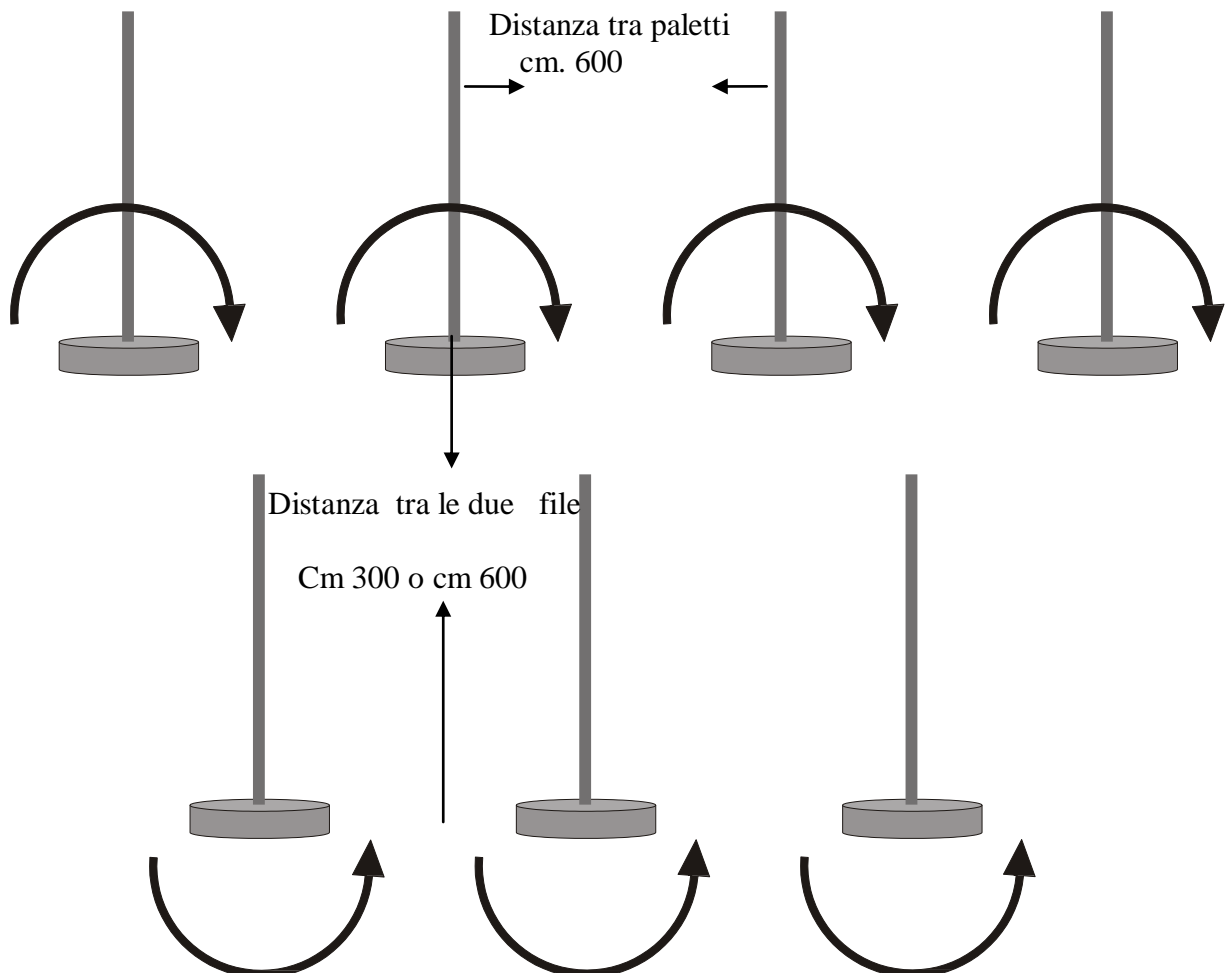

SLALOM DRITTO

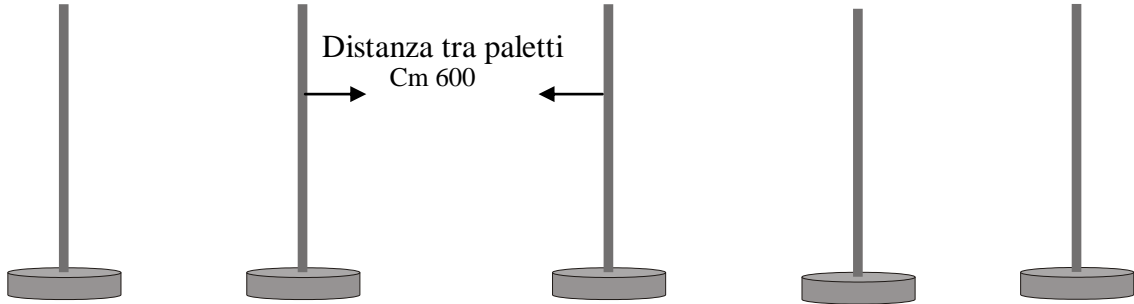

OTTO FRAI BARILI

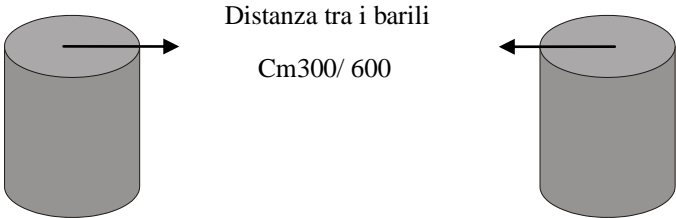

DOPPIO OTTO FRAI BARILI (FIGURATRIANGOLO)

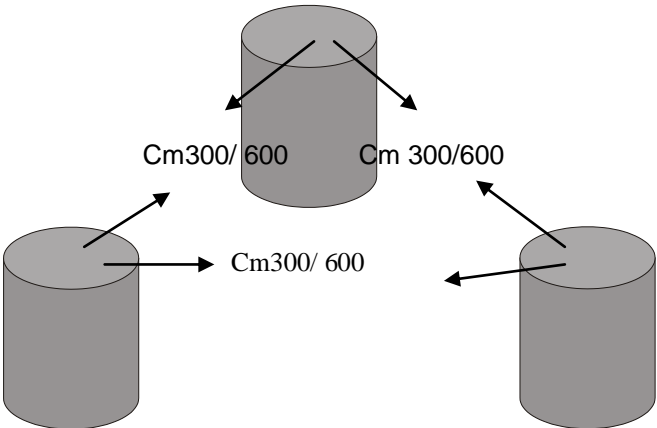

CANCELLO

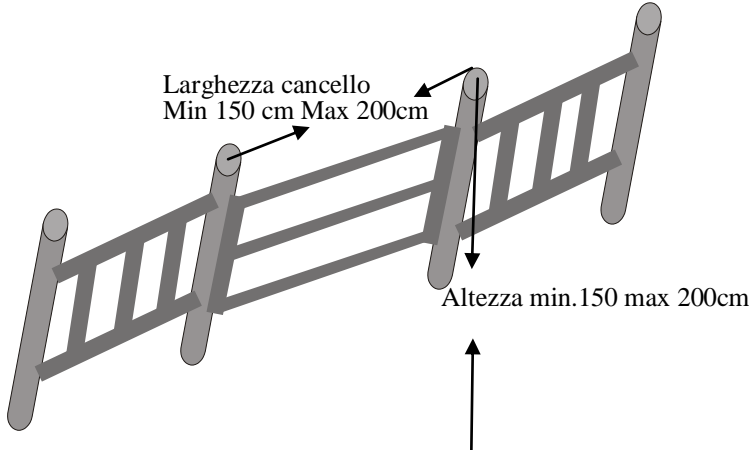

SCALAROLA

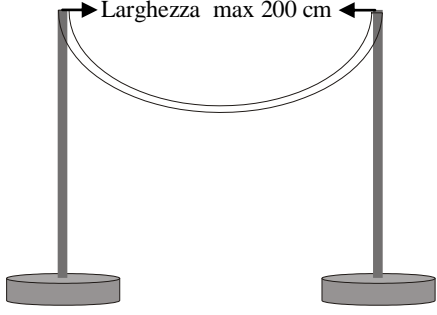

CORRIDOI

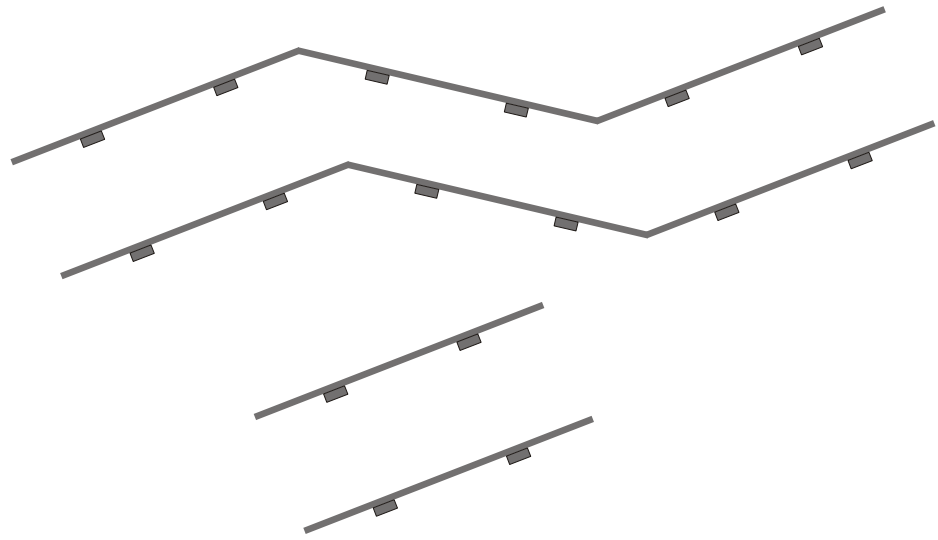
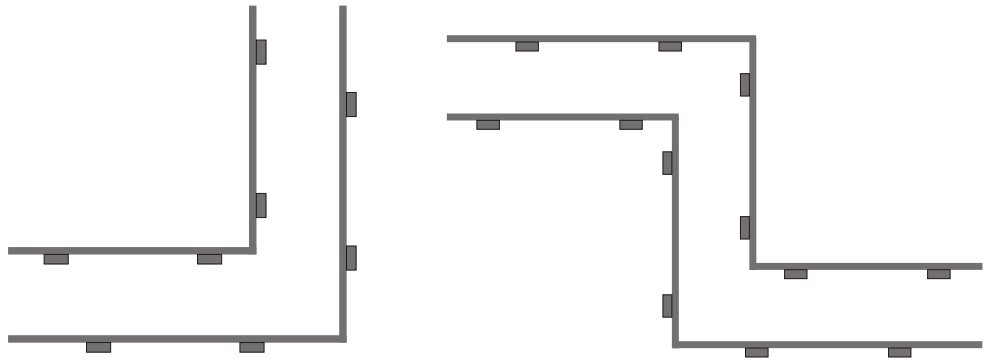
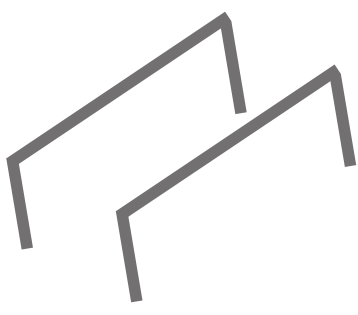

TALUS

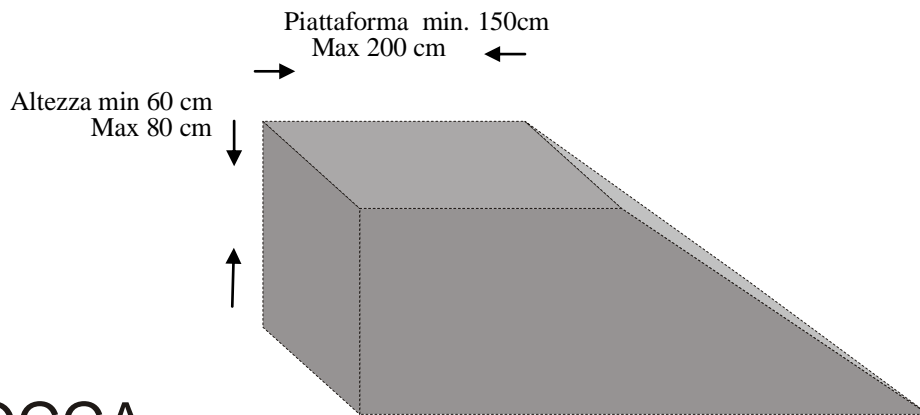

BROCCA

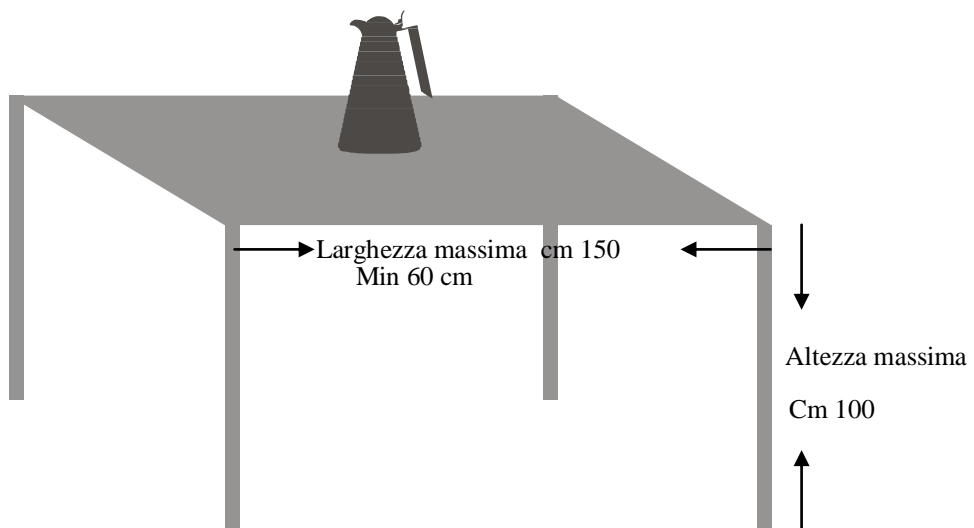

INFILARE UN LANCI A IN UN BARILE O ANELLO

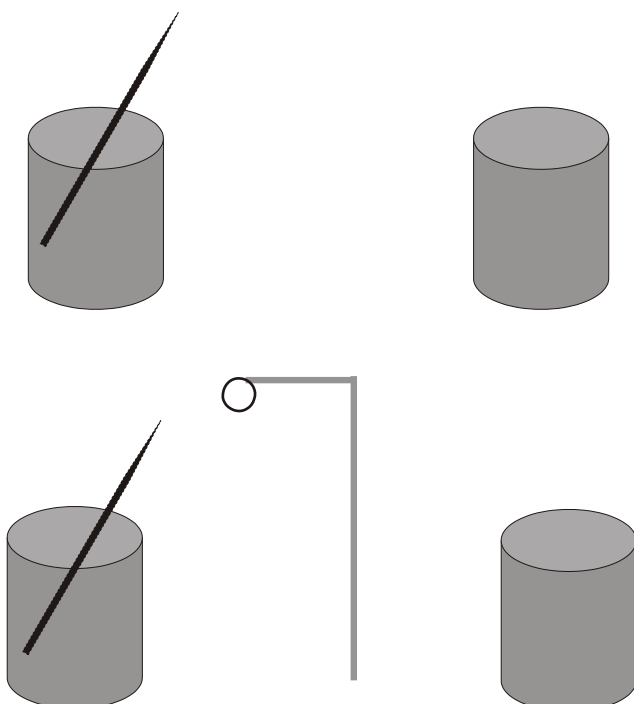

OVILE O GALINERO

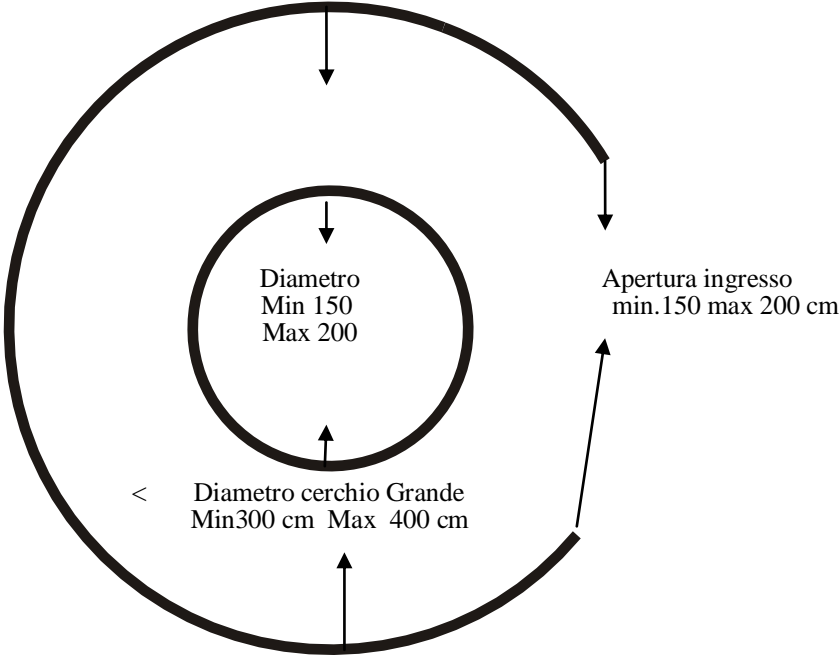

SALTO

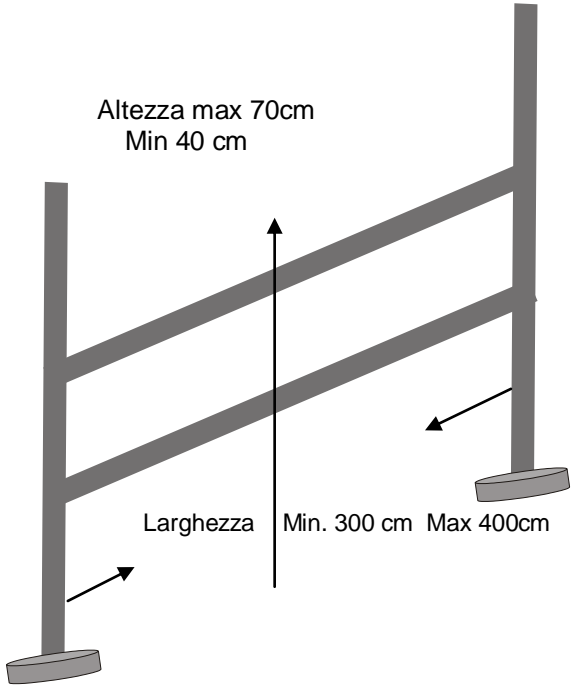

FOSSO CON ACQUA

