

# PASSI LATERALI

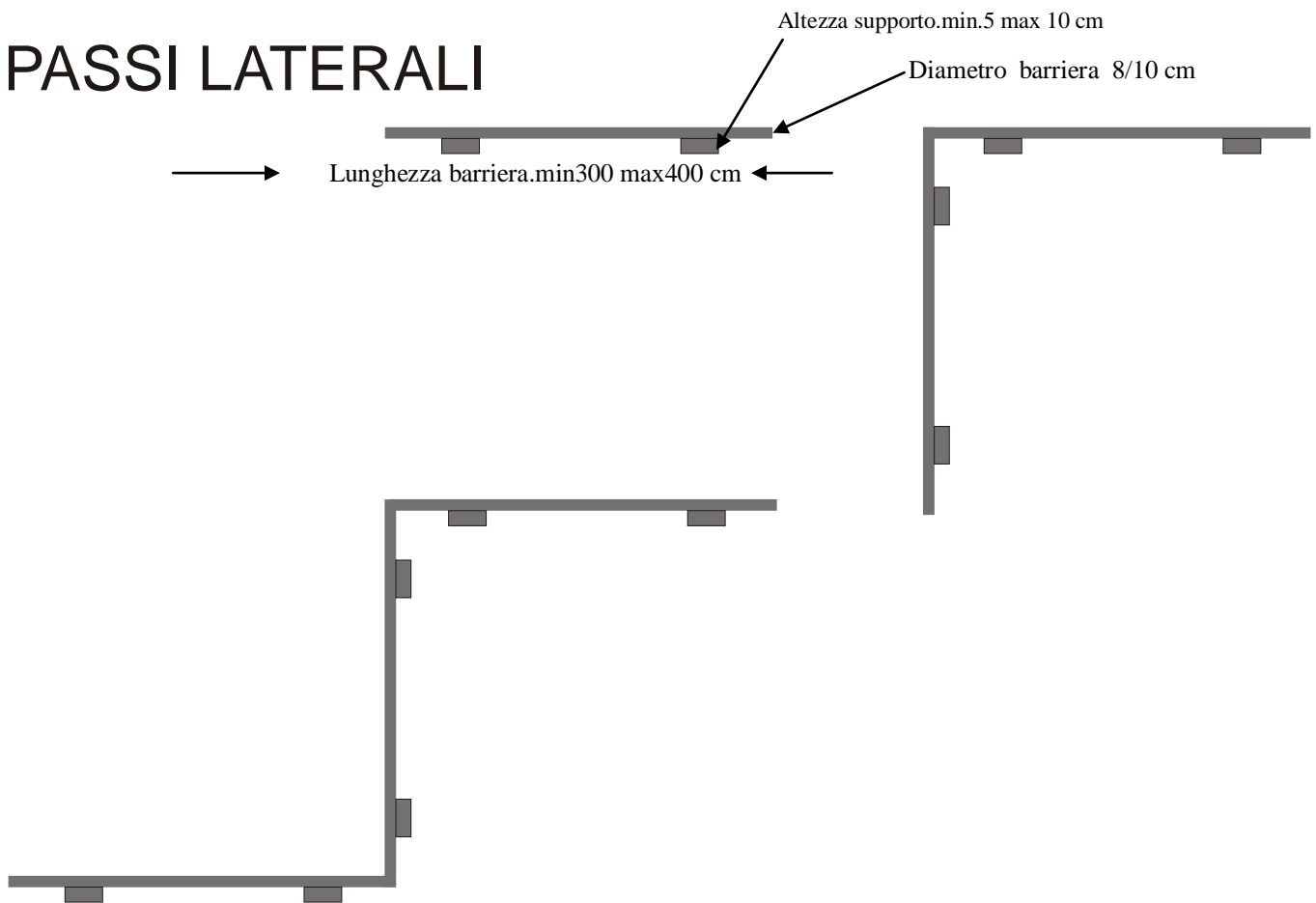

# PASSI LATERALI CON SPOSTAMENTO OGGETTO

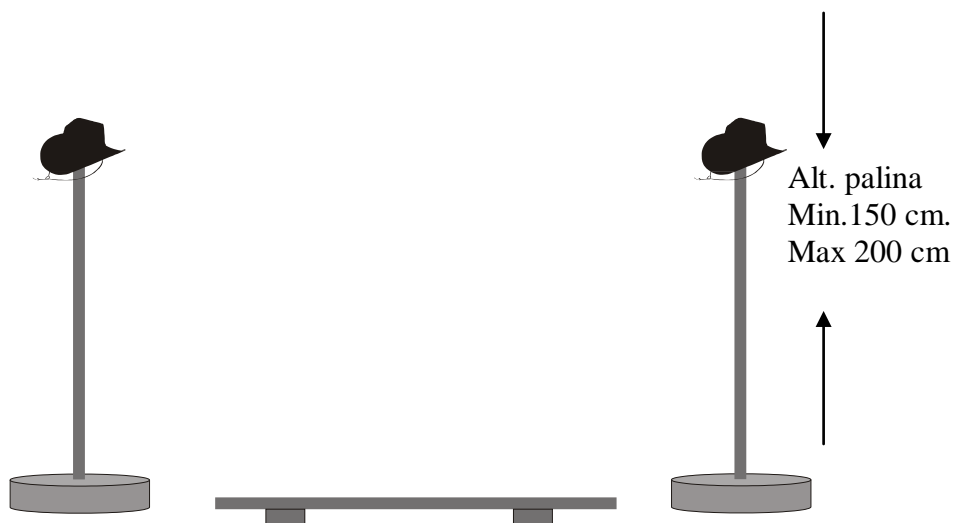

# PASSI INDIETRO A SLALOM

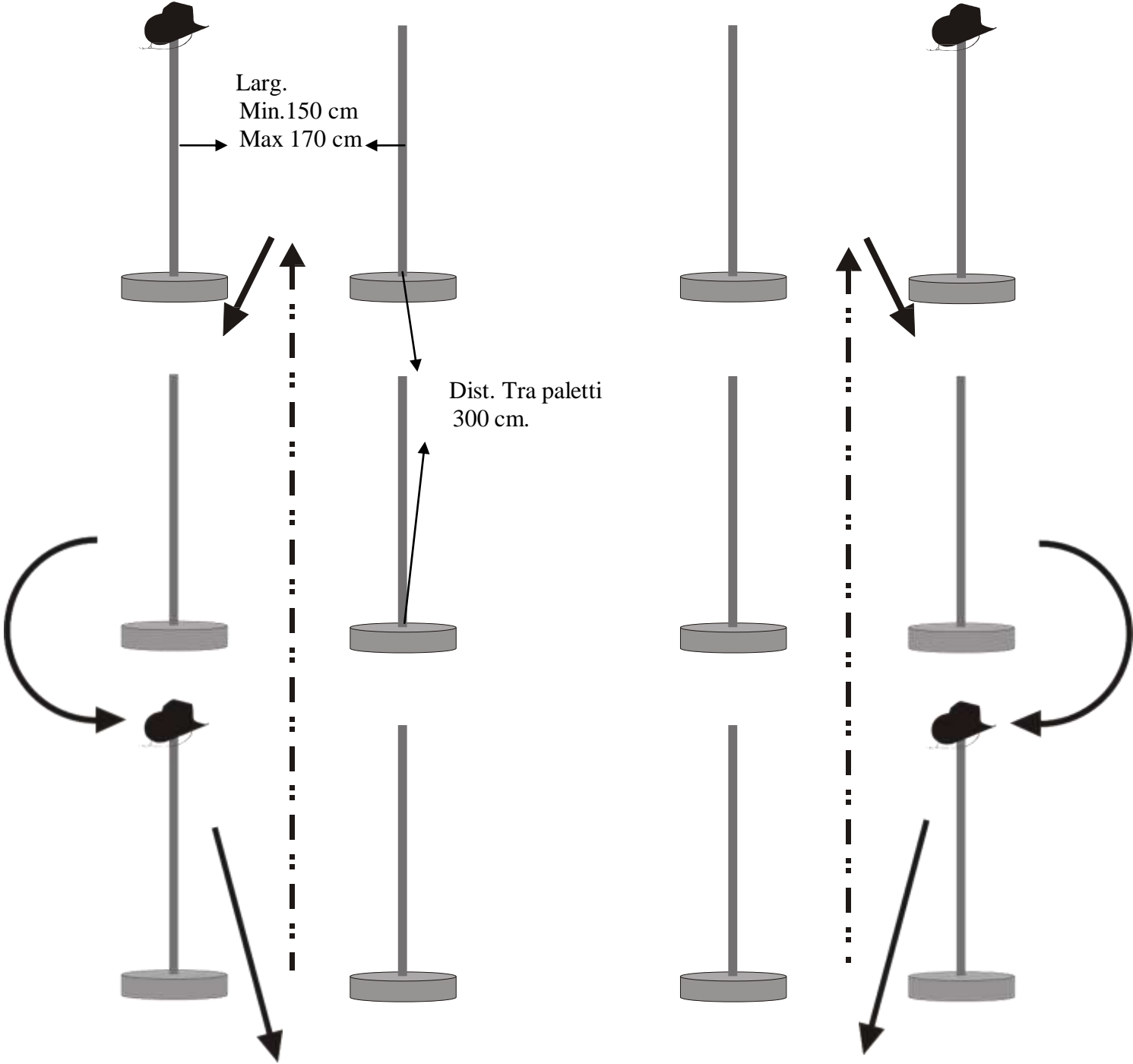

# TRASFERIMENTO DI UN OGGETTO

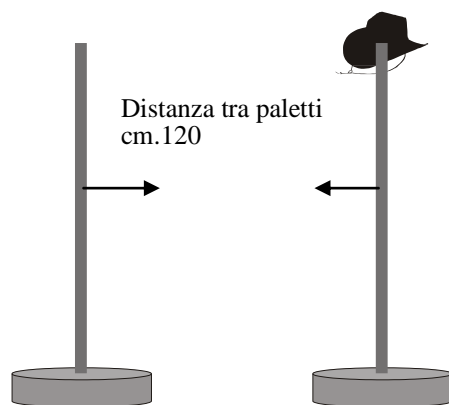

# PASSI INDIETRO DIRITTI CON TRASFERIMENTO DI UN OGGETTO

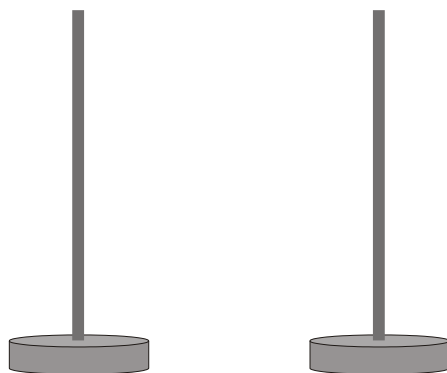
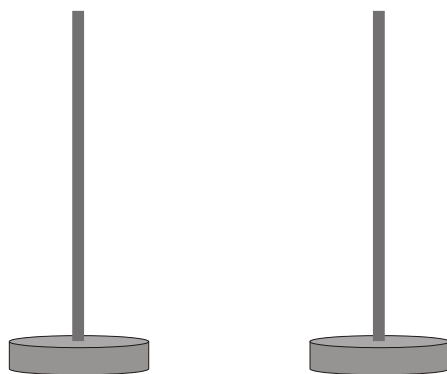
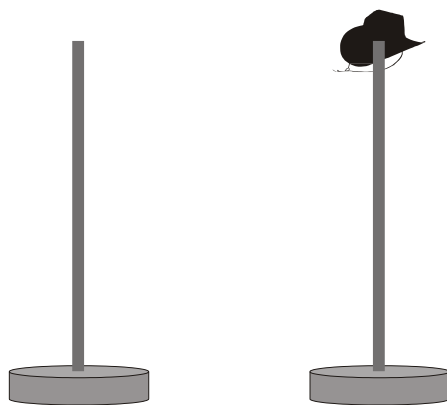

# PASSI INDIETRO

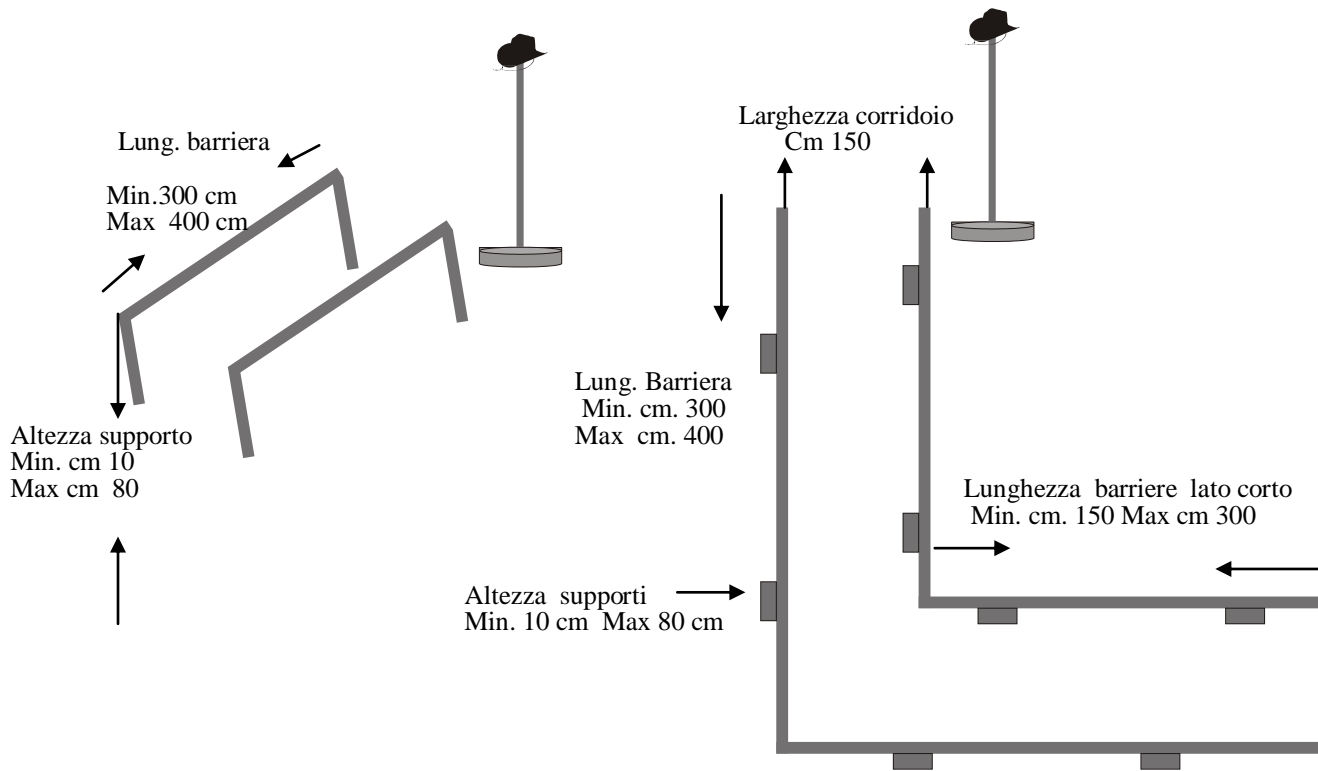

# QUADRATO

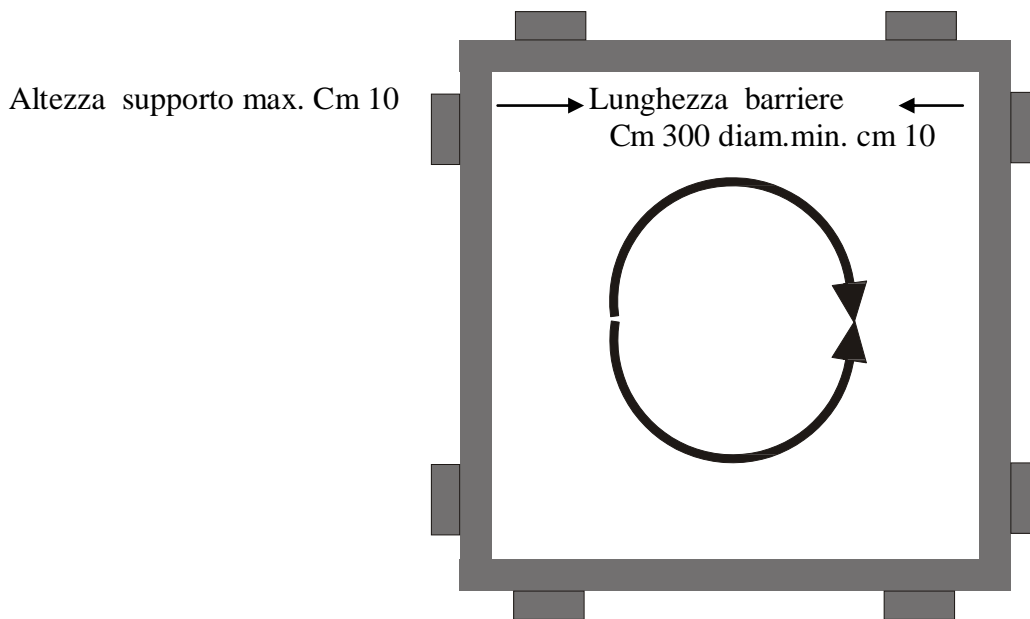

# PEDANA

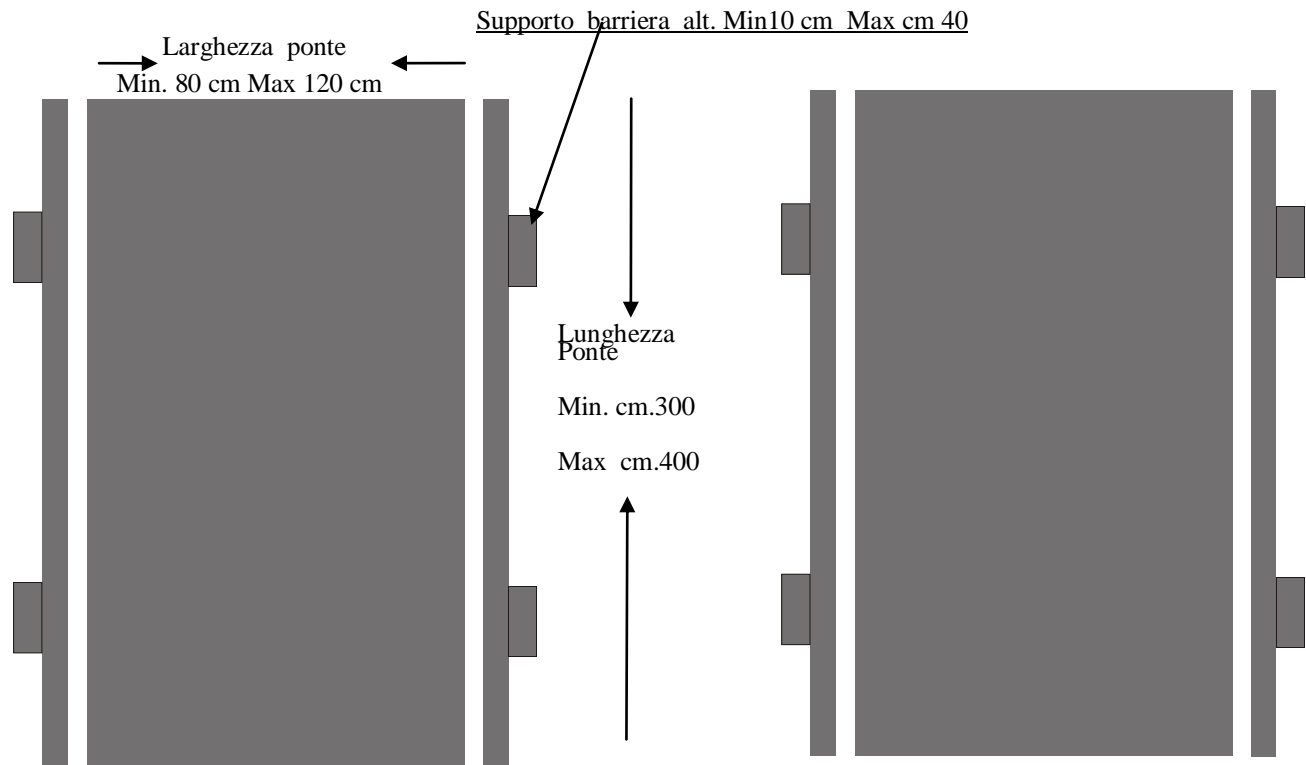

# SLALOM IN PARALLELO

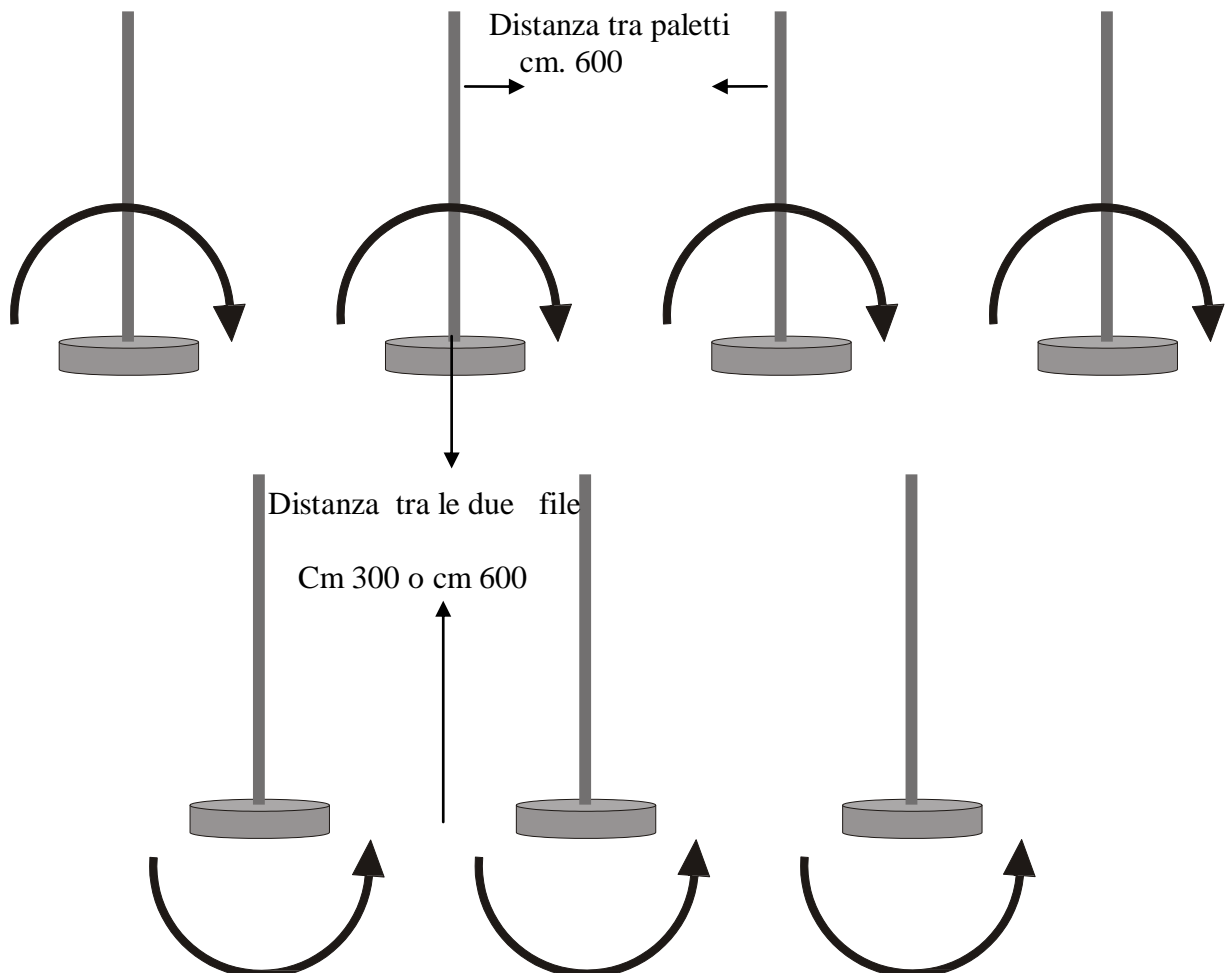

# SLALOM DRITTO

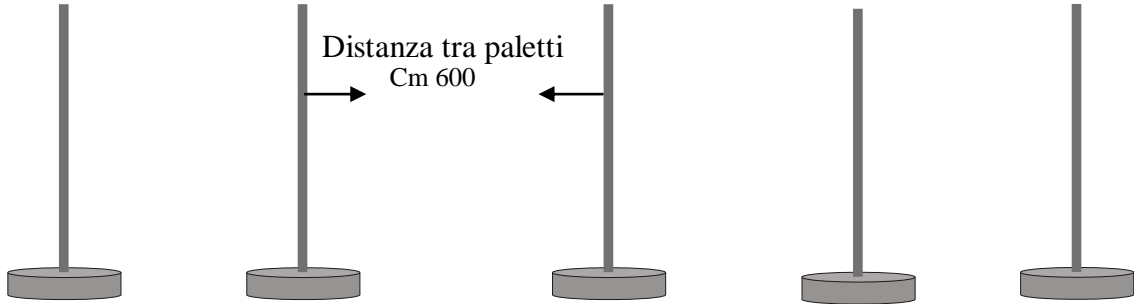

# OTTO FRAI BARILI

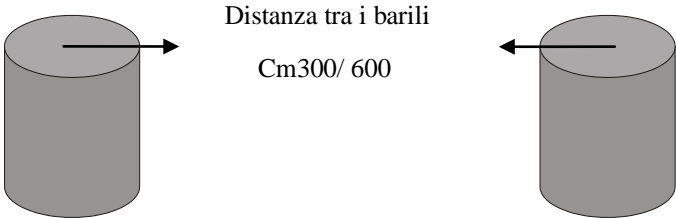

# DOPPIO OTTO FRAI BARILI (FIGURATRIANGOLO)

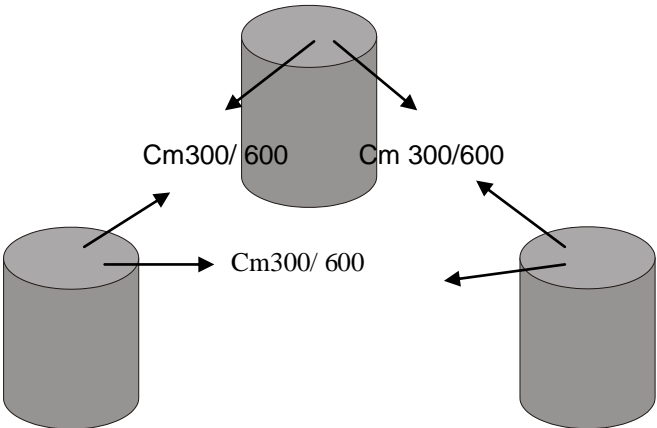

# CANCELLO

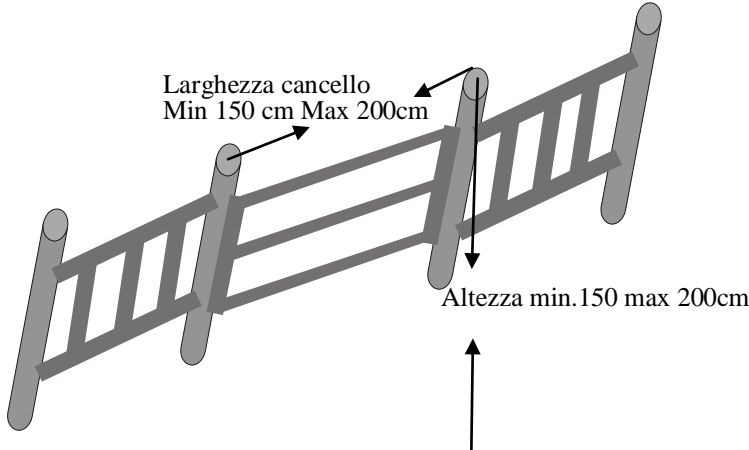

# SCALAROLA

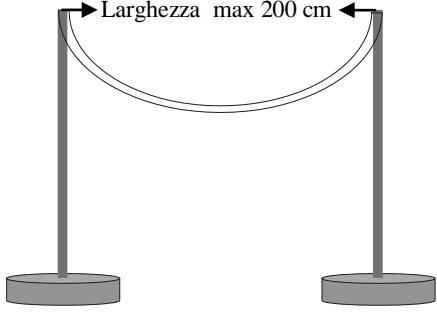

# CORRIDOI

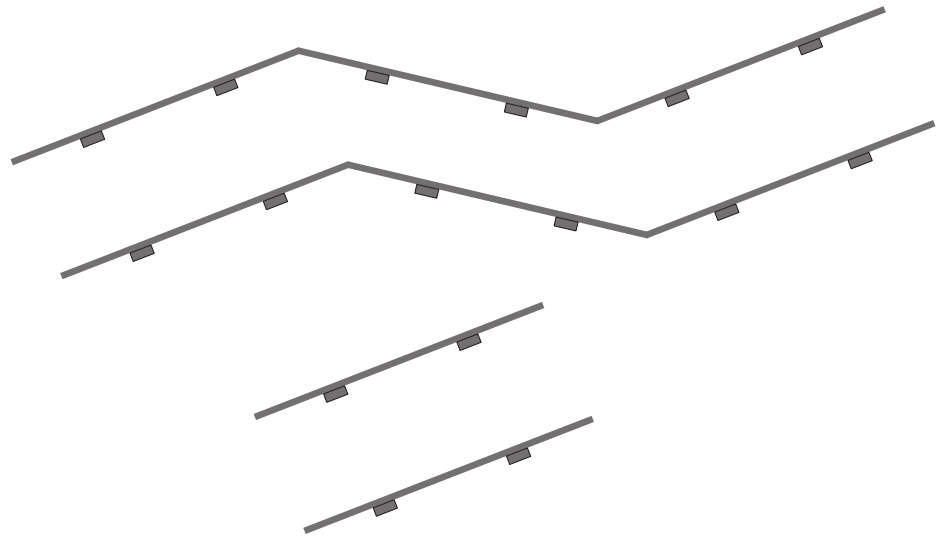
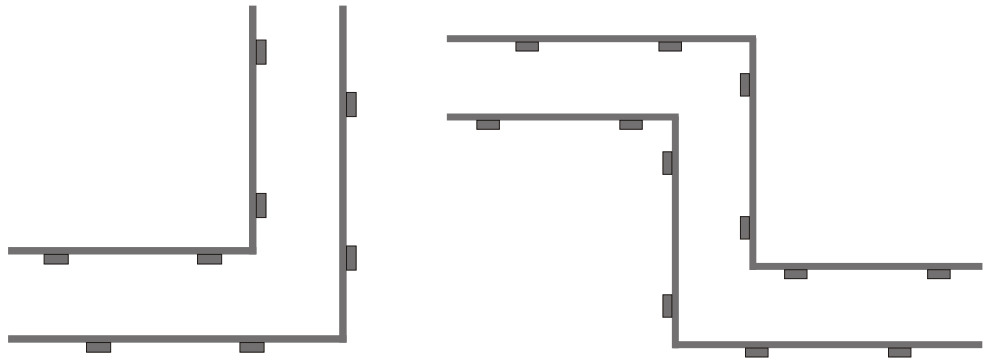
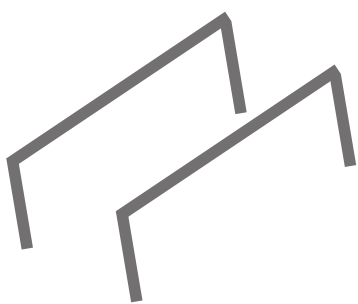

# TALUS

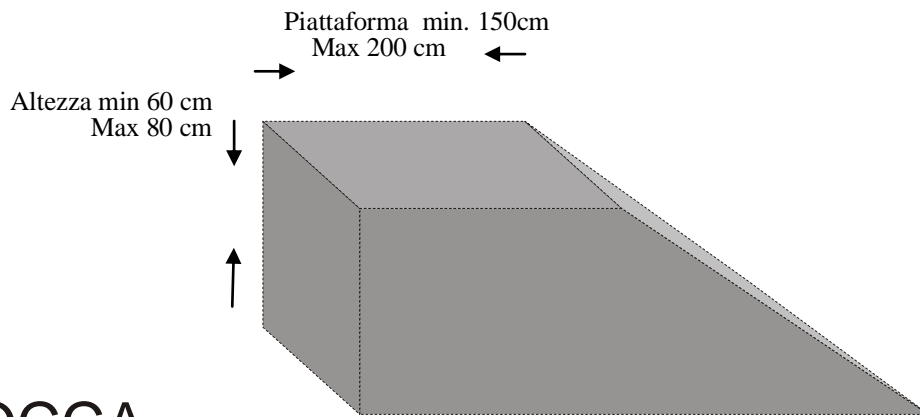

# BROCCA

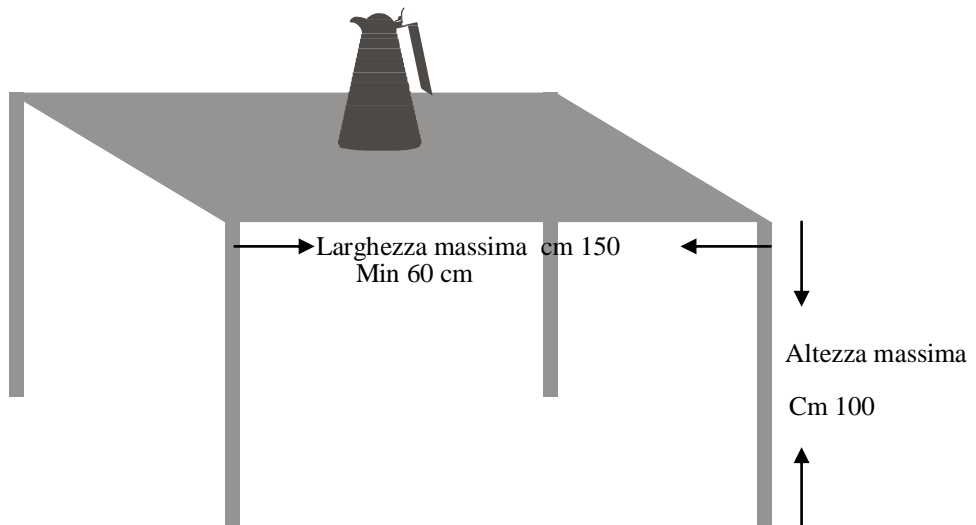

# INFILARE UN LANCI A IN UN BARILE O ANELLO

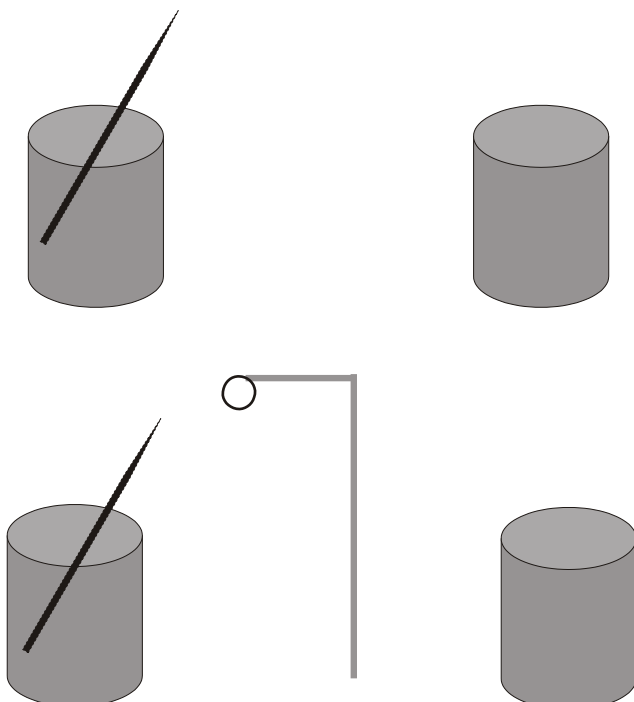



# OVILE O GALINERO

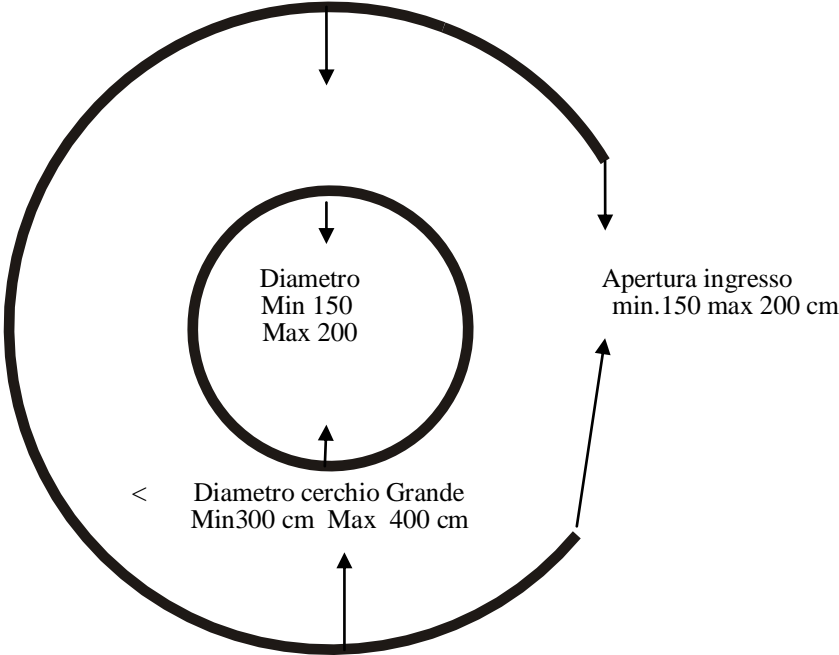

# SALTO

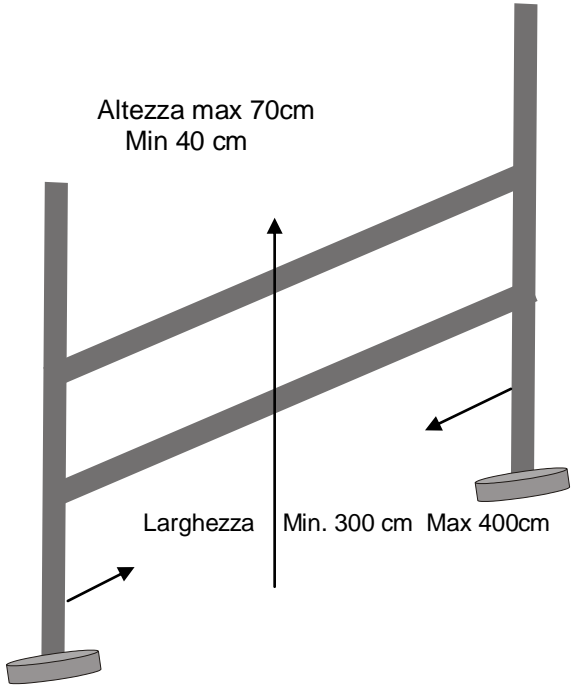

# FOSSO CON ACQUA

